

An Ideal solution for downsizing of equipment



- Compact size
- Short reading distance and a wide viewing angle

Height Width Depth
50 × 20 × 20 mm



For a wide range of products and applications

The WB1F has advanced scanning features and its compact size allows for flexible design of equipment.

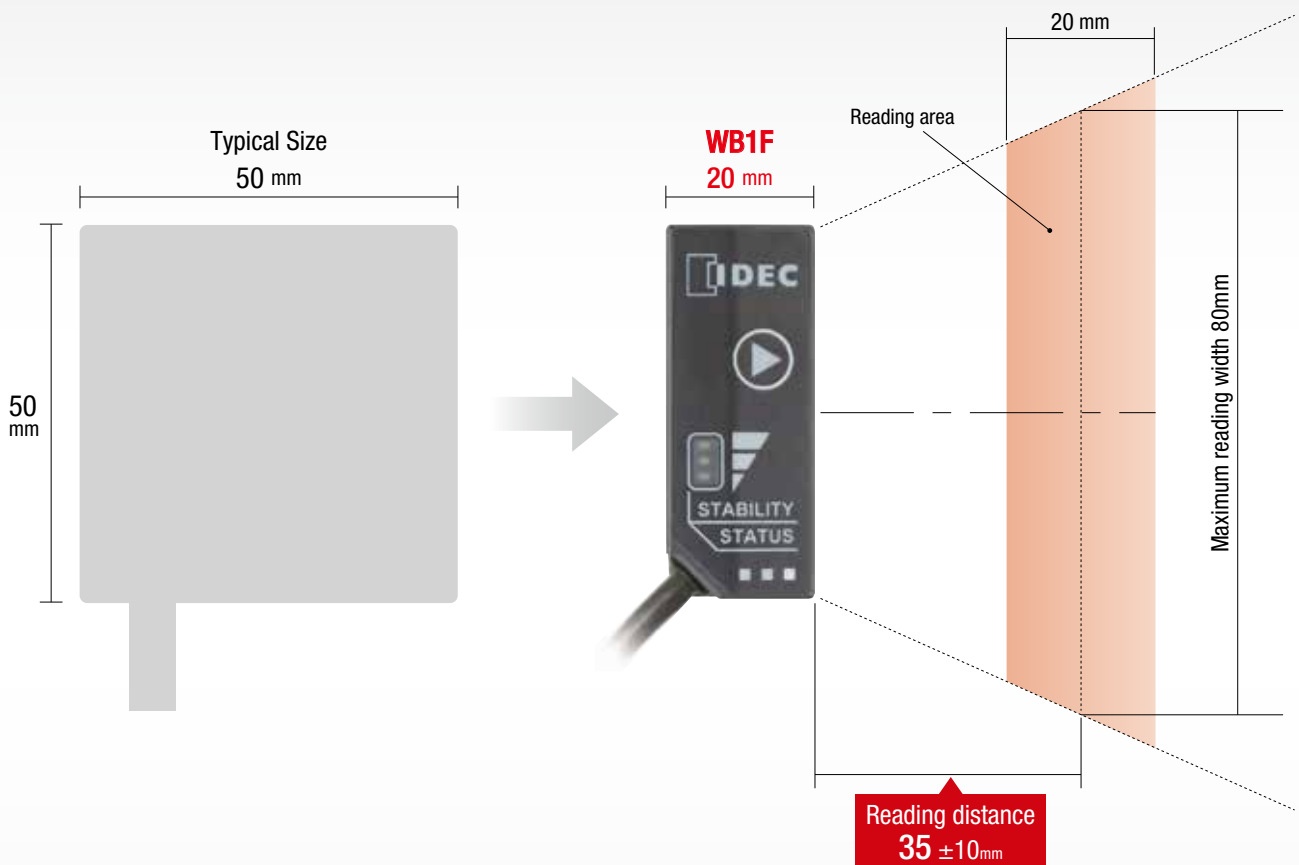
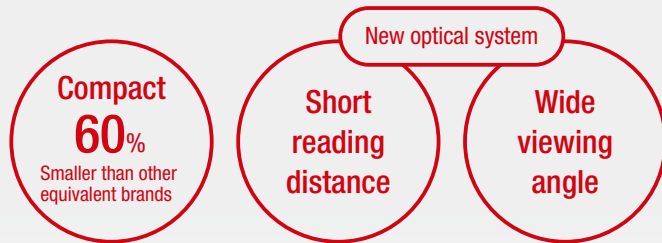

Wide viewing angle suitable for installing inside equipment

- ▶ IDEC's original optical technology achieves downsizing by **60% in volume**.
- ▶ Capable of a reading area within a **short distance range**.

* WB1F-100S1B (RS-232C type) is a UL/c-UL recognized component.

* WB1F-100S1S (USB type) is UL/c-UL listed.

* For details on the reading range, see page 5.

Application Examples

Downsizing of equipment enables flexibility in installation and can be used in various applications.

Medical Analysis Equipment

Application 01



Reads specimen labels, reagents, and test tube labels.

Entry Gates

application 02



Reads entry badges at buildings such as libraries and offices.

Payment Machines

application 03



Reads printed receipts to receive change from fee adjustment machines such as at gasoline stations.

Kiosk Terminals

application 04



Reads the barcode printed on a ticket. Ideal for checking information on a ticket.

Label Printers

application 05



Identifying information printed on the barcode of a label printer for scales.

Compact body with wide possibilities

WB1F

User-friendly installation support function

When aligning during installation, the reading status of the WB1F can be confirmed by the status LED, without having to check the host device.

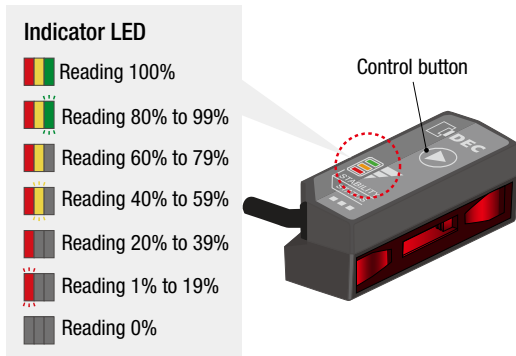

Sequential verification function

Data can be verified by sequential verification function. Master data does not need to be registered in advance and helps reduce work time.

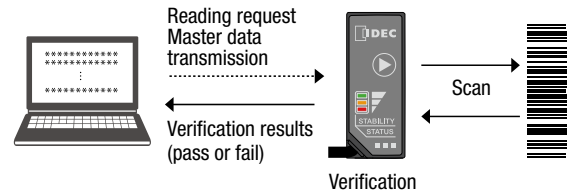

* Master data can also be registered in advance.

Firmware update function

Firmware can be updated with the WB1F installed on site.

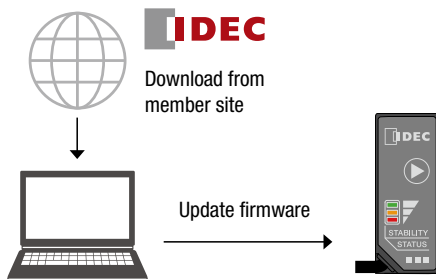

Flexible layout inside equipment

The side cable enables the WB1F to be installed near walls and increases flexibility inside equipment.

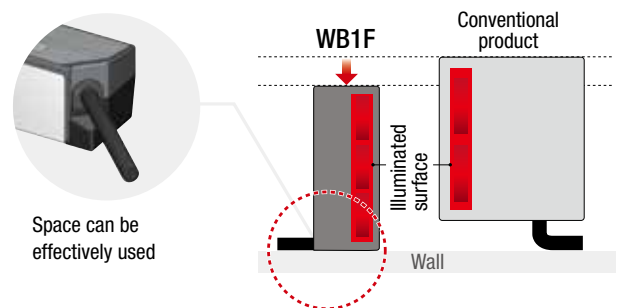

Various installation orientations are possible

Downsizing can be achieved by the compact size of the WB1F. Can be installed in various orientations.



WB1F

Communication interface	Part No.
RS-232C type	WB1F-100S1B
USB type	WB1F-100S1S

Specifications

Part No.	WB1F-100S1B	WB1F-100S1S
Rated power voltage	5V±0.25V DC	USB Bus power (5V DC)
Consumption current	200mA or less (peak 350 mA maximum)	
Control button	Equipped on unit (tactile switch) × 1	
Reading distance	35 ±10 mm (*1)	
Reading width	80mm (reading distance 35 mm) (*1)	
No. of digits read	64 digits max.	
PCS	0.45 or higher (*1)	
Minimum resolution	0.127mm	
Light source	Red LED (λp = 630nm)	
Reading method	Linear CCD image sensor (2,500 pixels)	
Reading confirmation	OK output, NG output, PWM output, indicator LED × 3	Indicator LED × 3
Number of scans	500 scans/seconds	
Communication interface	RS-232C (600 to 115,200bps)	USB 2.0 full-speed 12Mbps (virtual COM)
Connection type	Loose wires + shield 1m, 10C×AWG30 shielded cable	USB connector Type A 1m, 2P×AWG28 shielded cable
External trigger input	1 circuit Non-voltage contact (L active) Voltage input (VL: 1.0V, VIH: 4.0V-VCC)	—
OK output, NG output, PWM output	1 circuit each (3 circuits total) each (3 circuits in total) Open collector (sink) Max. rating 26.4V DC, 100mA	—

Part No.	WB1F-100S1B	WB1F-100S1S
Dielectric strength	500V AC (live part-dead part, 1 minute)	
Anti-static	Contact ±6kV, air ±8kV (IEC 61000-4-2)	
Operating temperature	0 to +40°C (no freezing)	
Operating humidity	30 to 85%RH (no condensation)	
Operating illuminance	5,000 lx or lower (under incandescent light)	
Storage temperature	-20 to +60°C (no freezing)	
Weight (approx.)	50g (when packed: 100g)	
Degree of protection	IP40	
Approved standards	UL/c-UL Recognized (*2)	UL/c-UL Listing
	CE marking (self declaration), VCCI (verification of conformity), FCC (verified), ICES-003 (self declaration)	
Codes to be read	EAN13/8 (including add-on), UPC-A/E/E1 (including add-on), CODE39, Codabar (=NW7), Interleaved 2 of 5 (=ITF), Standard 2 of 5 (=Industrial 2 of 5), Matrix 2 of 5, Chinese Post Matrix, COOP 2 of 5, SCODE, Code93, Code128, GS1-128 (formerly: EAN-128), MSI/Plessey, Italian Pharmacy (=Code32), CIP39, Tri-Optic, TELEPEN, Code11, GS1 DataBar (formerly: RSS) (*3)	

*1) When using IDEC barcodes
 *2) When using the WB1F as a UL approved product, use a limited power source or Class 2 power source for external power.
 *3) Omni-directional, Truncated, Limited, Expanded
 – Note that the specifications and other details described are subject to change without notice.

Dimensions

(Unit: mm)

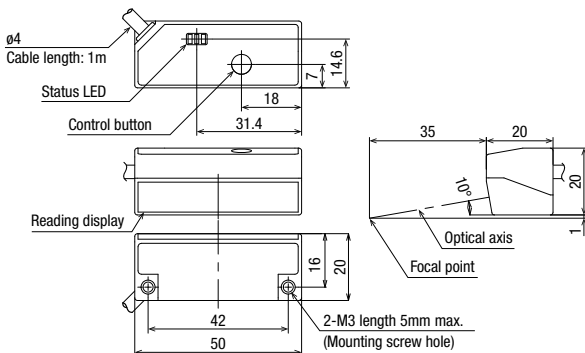

Reading range

(Unit: mm)

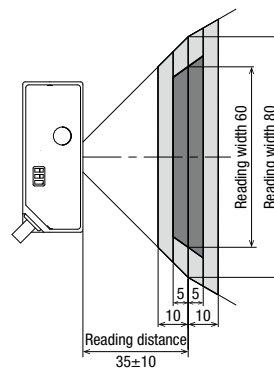

Note:
 Light gray: The reading range indicated in light gray is achieved when the reading resolution is 0.19 mm to 1.00 mm (PCS 0.9 or higher).
 Dark gray: The reading range indicated in dark gray is achieved when the reading resolution is from 0.127 mm (PCS 0.9 or higher).

Wiring / Terminal arrangement

Input / output circuit connection example (RS-232C type only)

OK output / NG output / PWM output

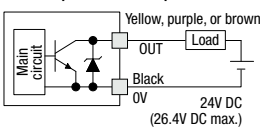

External trigger input

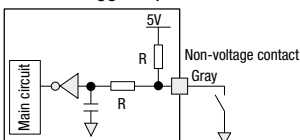

Wire colors and terminal arrangement

RS-232C type

Conductor color	Signal name	Function
Black	0V	Power supply- (combined SG)
Red	5VDC	DC Power supply+
Yellow	NG_0	NG output
Purple	OK_0	OK output
Blue	CTS	RS-232C control signal
Orange	RTS	RS-232C control signal
White	RXD	RS-232C received data
Green	TXD	RS-232C transmitted data
Gray	Ex_trig	External trigger input
Brown	PWM_0	PWM output

USB type

Pin number	Signal name	Function
1	VBUS	Bus power
2	D-	Data-
3	D+	Data+
4	0V	Ground



Note: For the RS-232C type, extend the cable length with a AWG30 or wider cable, in consideration of power drop. If the total cable length exceeds 2.8 m, it may have an impact on noise resistance. Do not extend the cable for USB type.

⚠ Safety Precautions

**Improper use of this product may cause severe injury or death.
Improper use of this product may cause injury or equipment damage.**

- Do not use this product in medical equipment, nuclear power, railways, aircraft, passenger vehicle equipment, or other applications requiring a high degree of reliability and safety, as it is not designed for these applications.
- When using this product in management system of chemicals or other applications with serious impact on human lives, take the utmost care with a redundant design and safety design, so that human lives are not threatened in the event incorrect data is used.
- Do not modify, disassemble, or repair. Otherwise serious accidents such as electric shock, damage, fire, or malfunction may result.
- If using this product as a part of electrical facilities for general use or connecting to such parts, use a 3rd party tested power supply. Do not use built-in power supply when not integrating this product into equipment, otherwise fire or electric shocks may result.
- Do not look directly at the reading window (transparent part) while LEDs are on (reading codes). Also do not project the light at others, otherwise eyes may be injured.
- This product is a general-purpose industrial electric device. Do not use for electric equipment which may damage the human body or threaten life in case malfunction or failure occurs.
- Power off before wiring or maintenance, otherwise electric shocks or failure will result.
- Do not connect this product to the power supply outside the rated voltage, or to an AC power supply. Otherwise electric shocks or failure will result.

- Wire the input and output circuits by referring to “Input / output circuit connection example” in the brochure. This product is not equipped with reverse connection circuitry of power supply. Pay extra attention to avoid the reverse connection of power supply, otherwise damage may be caused.
- Avoid parallel wiring of WB1F’s wires in the same conduit or duct with high voltage lines or power lines (in particular the inverter power lines). Inductive noise may cause malfunction or damage.
- Single wiring must be adopted in principle when the wires are long or when this product may be affected by power sources or electromagnetic devices.
- Do not install WB2F in the following locations subject to:
 - 1) Induction devices or heat sources
 - 2) Severe vibrations or shocks
 - 3) Severe dust
 - 4) Hazardous gas such as sulfurized gas
 - 5) Water, oil, or chemicals
 - 6) Outdoors
- This product is not explosion-proof. Before installation, make sure that the application does not require explosion protection performance

This equipment has been tested and found to comply with the limits for a Class B digital device, pursuant to Part 15 of the FCC Rules. These limits are designed to provide reasonable protection against harmful interference in a residential installation. This equipment generates, uses and can radiate radio frequency energy and, if not installed and used in accordance with the instructions, may cause harmful interference to radio communications and television reception near this equipment. Handle this equipment correctly in accordance with the instructions. VCCI-B

Instructions

- Power reset time is 300 ms. Start operating 300 ms after powering up
- When the load and WB1F are connected to different power supplies, make sure to turn on the power supply of WB1F first
- When installing, avoid direct sunlight or fluorescent light to the product.

Cleaning the reading window

- Dust, dirt, water, or droplets on the reading window (transparent area) may degrade the reading performance.
- Periodically check the reading window and clean if necessary.
 - 1) To clean, blow off dust with airbrush and clean gently using soft material such as a cotton swab.
 - 2) Wipe away water using soft cloth. Do not use any chemical, otherwise the optical part material may be affected. The material in the optical section is PMMA. Do not use organic solvents such as alcohol, paint thinner, or benzene, or ammonia and sodium hydroxide.

Cleaning the scanner unit

Clean the scanner unit using a soft dry cloth.

- 1) Do not use organic solvents such as alcohol, benzene, or paint thinner. Otherwise the housing quality may deteriorate, and the paint may come off.
- 2) Use neutral detergent diluted with water to wipe off severe dirt using cloth soaked in neutral detergent diluted with water, and re-wipe with a dry soft cloth.

Reading Data Analysis Function

The analysis function only reads digitally sampled analog signals of a barcode. A separate software is required to display waveforms. A confidentiality agreement must be signed with IDEC in order to use the analysis function. For details, contact IDEC or your sales representative.

Firmware Update Function

A dedicated software is required in order to perform the update.

Installing the driver

- Using the USB type

To use the USB interface, the dedicated Active USB-COM port drive (virtual COM port driver) must be installed on the host computer. For details on the installation procedure, refer to the instruction manual. The manual for the main unit can be downloaded from the IDEC website. If this product is used in an environment where the IDEC website cannot be accessed, please contact your sales representative.

Mounting

- Tighten the mounting screws to a torque of 0.4 to 0.5 N-m.
- Do not tighten the mounting screws excessively. Do not hit WB1F with a hammer, or apply excessive force on the root of the cable by pulling or bending the cable forcefully, otherwise the degree of protection cannot be maintained
- Do not use the mounting screws supplied with WB1F when installing on a panel of 2.3 mm or thicker.
- Ensure that the screw depth of the mounting screws is 3 mm to 5 mm.

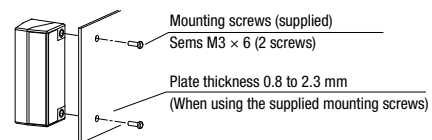

- Install WB1F in the position where the skew angle of barcodes are within the range shown below. Reading performance deteriorates extremely if the barcodes meet face-to-face with the optical axis.

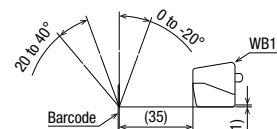

Precautions when discarding the product

- Dispose of the WB1F as an industrial waste.

IDEC CORPORATION

 www.idec.com

Head Office 6-64, Nishi-Miyahara-2-Chome, Yodogawa-ku, Osaka 532-0004, Japan

USA	IDEC Corporation	Singapore	IDEC Izumi Asia Pte. Ltd.	China	IDEC (Shanghai) Corporation	Japan	IDEC Corporation
EMEA	APEM SAS	Thailand	IDEC Asia (Thailand) Co., Ltd.		IDEC Izumi (H.K.) Co., Ltd.		
		India	IDEC Controls India Private Ltd.	Taiwan	IDEC Taiwan Corporation		

Specifications and other descriptions in this brochure are subject to change without notice.
Information in this brochure is current as of June, 2022.
2022 IDEC Corporation, All Rights Reserved.

EP1545-3

